



**INSTRUCTIONS D'ASSEMBLAGE**  
**ASSEMBLY INSTRUCTIONS**

---

**M**ONARCH  
SPECIALTIES INC.

# I 2006

---

**PATERE -**  
**70"H / METAL BLANC**

**COAT RACK -**  
**70"H / WHITE METAL**



**POUR DE L'ASSISTANCE OU POUR COMMANDER  
DES PIÈCES CONTACTEZ NOTRE DÉPARTEMENT  
DE SERVICE À LA CLIENTÈLE.**



**FOR ASSISTANCE OR TO ORDER PARTS  
CONTACT OUR CUSTOMER SERVICE DEPARTMENT**

**WWW.MONARCHSERVICE.COM**

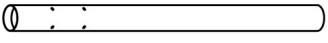
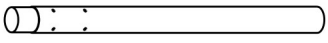
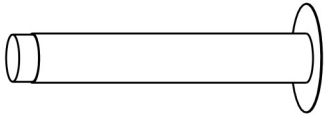
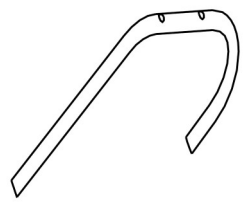
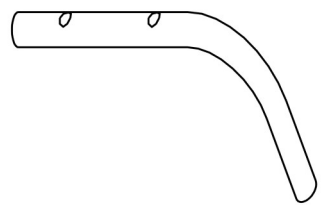

**LISTE DES PIÈCES**  
**PARTS LIST**

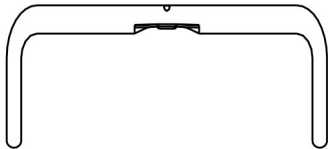
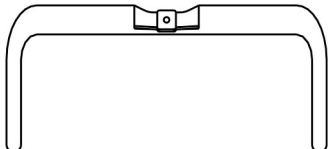
PIÈCE / PART #	IMAGE	DESCRIPTION	QTY / QTÉ
1		UPPER POST POTEAU SUPÉRIEUR	1
2		CENTER POST POTEAU DU CENTRE	1
3		BOTTOM POST POTEAU DU BAS	1
4		HOOK CROCHET	4
5		HOOK CROCHET	4

**LISTE DES PIÈCES**  
**PARTS LIST**

PIÈCE / PART #	IMAGE	DESCRIPTION	QTY / QTÉ
6		<p align="center">LEG PATTE</p>	1
7		<p align="center">LEG PATTE</p>	1
8		<p align="center">FINIAL FLEURON</p>	1
9		<p align="center">FINIAL SUPPORT SUPPORT DE FLEURON</p>	1

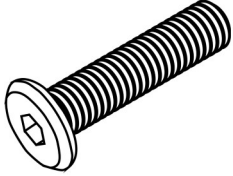
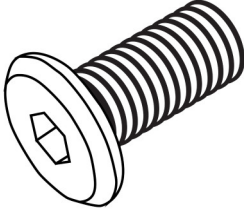
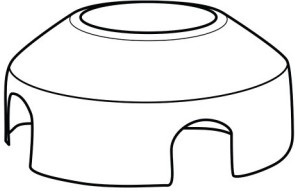
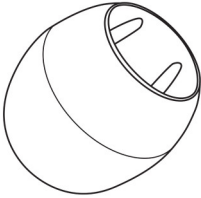
**LISTE DES PIÈCES DE MONTAGE**  
**HARDWARE LIST**

PIÈCE / PART #	IMAGE	DESCRIPTION	QTY / QTÉ
A		ASSEMBLING BOLT - Ø 3/8" X 1 1/2" BOULON D'ASSEMBLAGE - Ø 3/8" X 1 1/2"	1
B		ASSEMBLING BOLT - Ø 1/4" X 3/4" BOULON D'ASSEMBLAGE - Ø 1/4" X 3/4"	16
C		SUPPORT - Ø 3 3/8" SUPPORT - Ø 3 3/8"	1
D		CAP - Ø 1/2" CAPUCHON - Ø 1/2"	12
E		CAP - Ø 7/8" CAPUCHON - Ø 7/8"	4

**LISTE DES PIÈCES DE MONTAGE**  
**HARDWARE LIST**

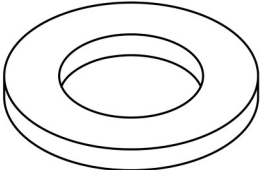
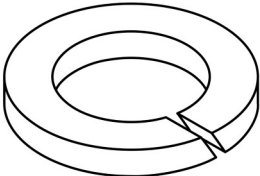
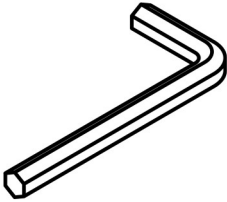
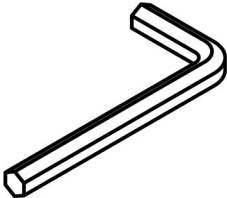
PIÈCE / PART #	IMAGE	DESCRIPTION	QTY / QTÉ
<b>F</b>		CAP - Ø 1/2"  CAPUCHON - Ø 1/2"	<b>4</b>
<b>G</b>		METAL WASHER RONDELLE DE MÉTAL	<b>1</b>
<b>H</b>		LOCK WASHER ENTRETOISE DE MÉTAL	<b>1</b>
<b>I</b>		HEX KEY - M5 , 4M  CLÉ HEXAGONALE - M5 , 4M	<b>1</b>
<b>J</b>		HEX KEY - M4 , 3M  CLÉ HEXAGONALE - M4 , 3M	<b>1</b>



OUTIL DE VÉRIFICATION DE DIMENSIONS DES PIÈCES  
HARDWARE DIMENSIONS VERIFICATION TOOL

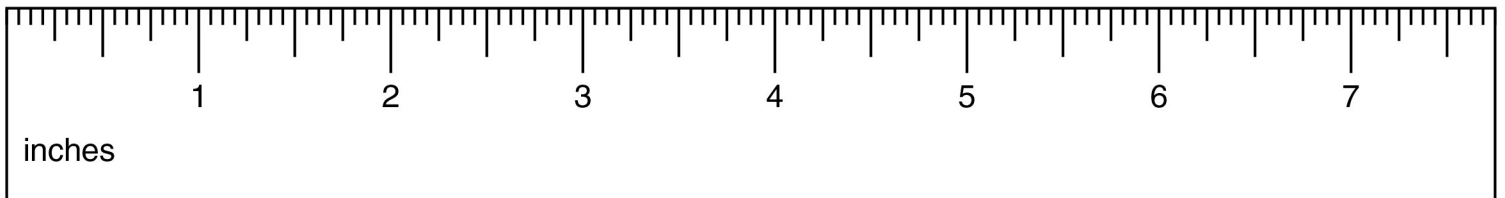

ÉTAPE / STEP 1

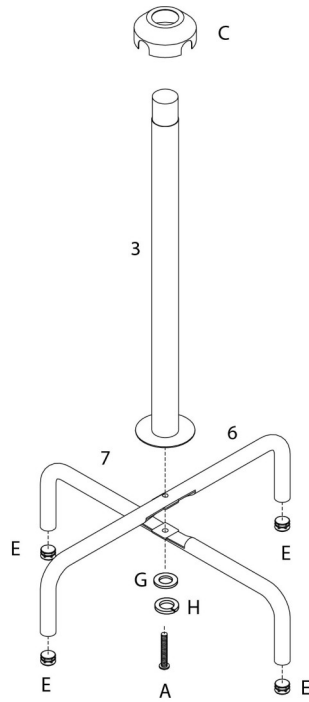

ÉTAPE / STEP 2

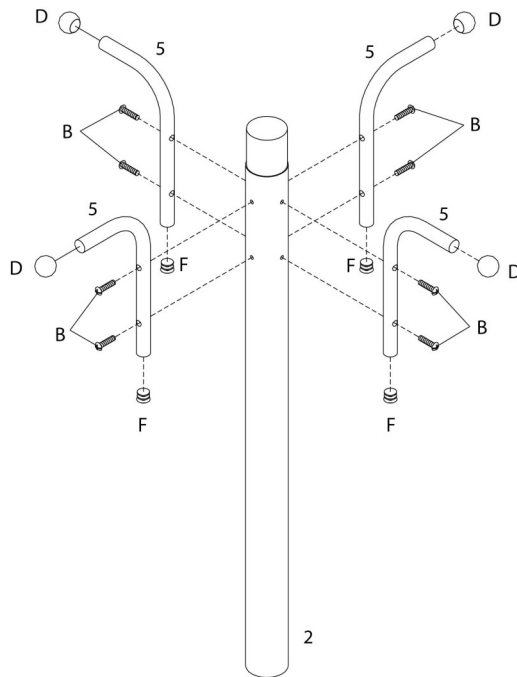

ÉTAPE / STEP 3

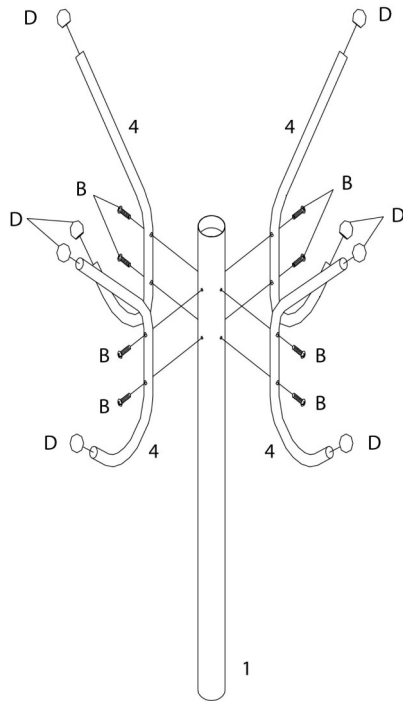

ÉTAPE / STEP 4

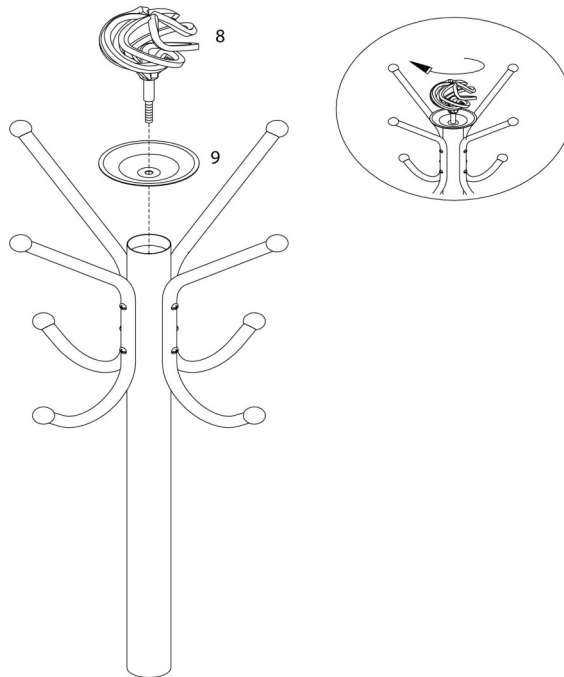



ÉTAPE / STEP 5

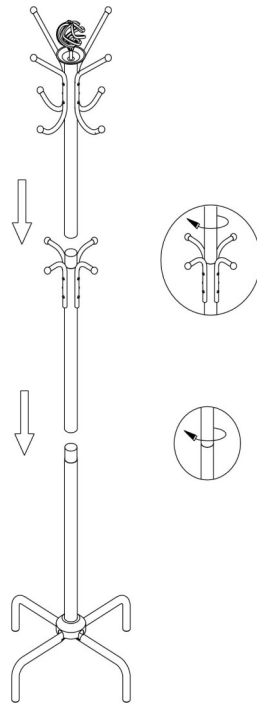

ÉTAPE / STEP 6

